

LH-6

1-6X24 SFP LPVO Product Manual

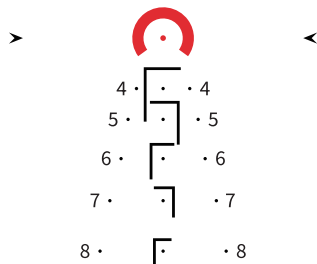

ARKEN OPTICS

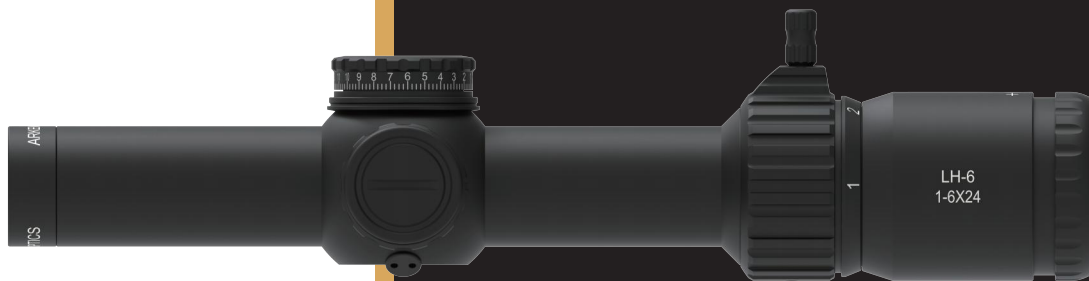

ARKEN OPTICS USA
www.arkenopticsusa.com

ARKEN OPTICS GLOBAL
www.arkenoptics.com

Table of Contents

Welcome	01
1-6X24 Specifications	02
Features	03
Mounting Tips and Tricks	04
Eyepiece/Diopter	05
Magnification Ring	05
Illumination Turret	06
Elevation And Windage Turrets	06
Windage and Elevation Adjustments	07
Instructions For Use	08
Zero-Reset	08
The Subtension Scale: MOA	09
Introducing the KLBOX Reticle	10
Frame and Fire!	10



Welcome

LH-6 1-6X24 SFP

Arken Optics LH6 1-6X LPVO (Lower Power Variable Optics) is designed to deliver unrivaled experiences that meets the demand of competitive shooters, hunters, and tactical teams.

Constructed from hardened aircraft grade aluminum, LH-6 is nitrogen purged to ensure utmost reliability and durability in the harshest environments.

With true 1x magnification and ultra-wide FOV of 24 degrees, LH-6 provides all shooters with an excellent tool to take that perfect shot from Close Quarter Combat to long range engagements.



Specifications



1-6X24

Magnification:	1X-6X	Elevation Adjustment Range:	180MOA
Objective Lens Diameter:	24 mm	Windage Adjustment Range:	180MOA
Eye Relief:	3.74 inches	Elevation Adjustment Per Revolution:	25 MOA
FOV@1X:	133.5' 24deg	Windage Adjustment Per Revolution:	25 MOA
FOV@6X:	21.2' 4.06deg	Illuminated Reticle:	Red
Tube Size:	30 mm	Turret Rotation:	Counter Clockwise (CCW)
Turret Adjustment:	1/4 MOA	Color:	Matte Black
Reticle Position:	Second Focal Plane	Length:	10.64 inches
Reticles:	BDC Style - KLBOX	Weight:	20.16 oz
Throw Lever:	Integrated / Removable	Battery Model:	CR2032

Features



- A** Eyepiece / Ocular Lens
- B** Diopter / Ocular Focus Ring
- C** Magnification Ring / Throw Lever
- D** Illumination Turret
- E** Battery Cap
- F** Elevation Turret (Turret caps screw over turret)
- G** Windage Turret (Turret caps screw over turret)
- H** Objective Lens

Mounting Tips and Tricks



When it comes to securing your LH-6 to your firearm, getting it right the first time is crucial for accurate shooting. Here are some tips and tricks to ensure your scope is mounted correctly on your rifle.

- 🔺 **We recommend using ARKEN OPTICS Mounts:** Select mounts designed to complement ARKEN scopes, ensuring a seamless and stable connection between your scope and rifle.
- 🔺 **Clean and Degrease:** Before mounting, clean the mounting surfaces on both the rifle and the scope. Remove any old oil or residue to ensure a solid connection.
- 🔺 **Torque Wrench is Your Friend:** Use a torque wrench to tighten screws to the recommended specifications. This ensures consistent pressure and prevents over-tightening.
- 🔺 **Properly Level the Scope:** A leveling tool helps ensure the scope is perfectly aligned with the rifle. This step is often overlooked but is crucial for accuracy.
- 🔺 **Eye Relief:** Position the scope to achieve the proper eye relief for your shooting style. This is the distance between your eye and the scope.
- 🔺 **Bore Sighting:** Before finalizing the mounting, perform a bore sight. This gets your scope on paper before you head to the range for fine-tuning.
- 🔺 **Recheck and Test:** After mounting, recheck all screws for tightness. Take your rifle to the range and test for accuracy.
- 🔺 **Consider Recoil:** If you're mounting on a high-recoil rifle, ensure there's enough eye relief to prevent scope bite.
- 🔺 **Apply Thread Locker Sparingly:** Use a small amount of thread locker on screws and bolts to prevent them from loosening due to recoil vibrations. Gently apply Thread locker. We recommend blue locktite.
- 🔺 **Consult a Professional:** If you're unsure, seek advice from a professional gun smith. They can ensure your scope is mounted perfectly.

A well-mounted scope can make a world of difference in your shooting experience. Following these tips will help you achieve the best results with your scope.

Eyepiece/Diopter (A&B)

To adjust reticle focus, rotate the diopter ring while looking at an unobstructed background, and it's recommended to use the sky as background. Your eye will continually refocus at the reticle, so this should be done in short intervals. Look away between each adjustment to allow your eye to focus back on the sky. Then quickly look back at the reticle and make the necessary diopter adjustment. The reticle should appear to be sharp and should not appear to move when you move your head. Once properly set, the eye should not have to work to get the reticle in focus.

Magnification Ring (c)

To obtain the desired magnification, rotate the Magnification Ring so that the indicator on the Ring corresponds with the magnification power level on the scope body.



Illumination (D)

In low light or low contrast conditions, you can turn on the illuminated reticle. The reticle will turn red to facilitate observation and aiming. The multiple different brightness levels are provided for various lighting conditions. The illumination is powered by a single CR2032 battery.



Elevation And Windage Turrets (F&G)

The elevation turret moves the reticle up or down, and the windage turret moves the reticle left and right. Rotate the elevation turret counterclockwise to move the reticle up and clockwise to move the reticle down. Rotate the windage turret clockwise to move the reticle left, counterclockwise to move the reticle right.



Windage and Elevation Adjustments



Making precise adjustments to windage (horizontal) and elevation (vertical) settings on your LH-6 scope is crucial for achieving accurate shots. Following are the quick guidance of the process:

1. Locate the Turrets:

Identify the windage and elevation turrets on the scope body. Looking directly at the eyepiece, the windage turret is located on the right side, and the elevation turret is on top. The windage and elevation turrets are the only turrets that have caps on them that cover them completely.

2. Understand the Directional Movements:

Windage: Turning the windage turret clockwise moves the point of impact to the left and counter clockwise moves it to the right.

Elevation: Rotating the elevation turret clockwise lowers the point of impact and counterclockwise raises it.

3. Making Adjustments:

Windage: Use the windage turret to move the point of impact horizontally, aligning it with your point of aim.

Elevation: Utilize the elevation turret to adjust the point of impact vertically, aligning it with your point of aim.

4. Recording Changes:

Keep track of the adjustments made. Scopes use Minute of Angle (MOA) or Milliradian (MRAD) measurements for precision.

5. Fine-Tuning:

Fire additional shots, making minor adjustments as needed to achieve the desired point of impact.

Remember, each click of the turret represents a specific angular measurement.

It's recommended to get familiar with the scope specifications and ballistic calculations for more accurate adjustment.

Instructions For Use



Sight In

1. Bore-Sighting Preparation:

Begin by bore-sighting your rifle. This helps to get your initial shots are close to the point of aim.

2. Firing Initial Rounds:

Fire a series of three to five rounds at the target.

3. Measure POA VS POI:

Determine the difference between the point of aim (POA) and the point of impact (POI). Use the reticle or a measuring directly on the target with a ruler.

4. Adjust Elevation and Windage:

Using the adjustment turrets, make the necessary changes to move the POA to the POI.

5. Confirmation Rounds:

Fire an additional three to five rounds to verify your zero. Continue making adjustments until the POA and POI coincide.



Zero-Reset

After you have zeroed the scope, loosen the screw of the elevation turret, then remove the turret cap. Realign the 0 position of the cap with the scale line on the scope body, and tighten the screws of the elevation turret.

The Subtension Scale:MOA



After you have zeroed the scope, loosen the screw of the elevation turret, then remove the turret cap. Realign the 0 position of the cap with the scale line on the scope body, and retighten the screws of the elevation turret.

MRAD (Milliradian): 1/1000 th of 1 radian of arc

1 MIL= 3.438 MOA

1 MIL= 3.599 inches@ 100 yards

1/10 MIL= 0.359 inches@ 100 yards

MOA							
100 yds	200 yds	300 yds	400 yds	500 yds	600 yds	700 yds	800 yds
1"	2"	3"	4"	5"	6"	7"	8"

MOA (Minute of Angle): 1//60th of 1 degree of arc 1 MOA = 1.047 inches @ 100 yards, 1/4MOA = 0.261@ 100 yards.

Introducing the KLBOX Reticle (Pronounced "Kill Box")



The KLBOX Reticle covers the typical 5.56 and 7.62 cartridges, which is a revolutionary Ballistic Drop Compensation (BDC) style design, deliberately crafted to enhance performance in tactical scenarios, more suitable for instinctive real-time quick decisions.

Easy Distance Reference

Extending diagonally below the centerline, the outer numerical markers represent distances in yards. Those along the right and left edges serve as general references, each denoting 100-yard intervals starting at 400 yards. 4 = 400 yards | 5 = 500 yards | 6 = 600 yards | 7 = 700 yards | 8 = 800 yards

Wind Assistance and Moving Targets

A dot adjacent to each number signifies a 7mph wind hold for 5.56 and a 10mph wind hold for 7.62. The arrows flanking the centerline provide approximate holds for moving targets in their respective directions.

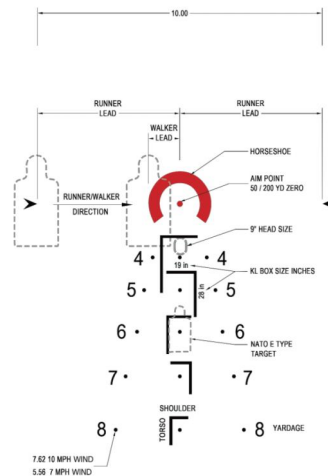

Frame and Fire!

With the KLBOX Reticle, aligning a silhouette target becomes a seamless process. By using natural reference points like shoulder, torso, and head measurements, you can swiftly gauge the distance. Engineered with combat effectiveness in mind, this reticle simplifies distance estimation within the operational range of 1X-6X. This means quicker target acquisition and more effective shots down range.

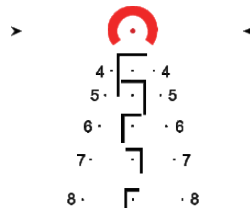

8X ZOOM
KL BOX RETICLE

LH-6

Measurement Reference

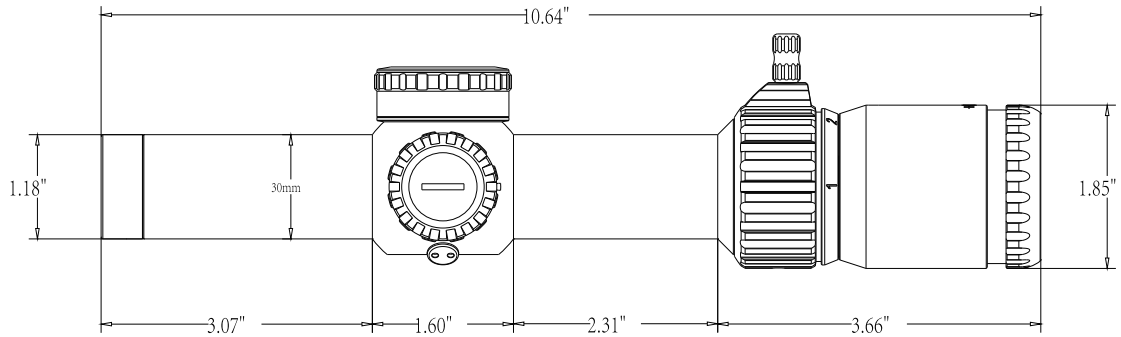







RUGGED PRECISION





All trademarks, graphics, and designs herein are the property of **ARKEN OPTICS**. Product specifications are subject to change without notice. Product manual is subject to change without notice. Products received may differ in appearance from those shown. ARKEN OPTICS is not responsible for typographical errors, data errors, or user ability/execution. ARKEN OPTICS is not responsible for results in real-time execution due to user ability.

○ ARKEN OPTICS GLOBAL

-  www.facebook.com/arkenopticsglobal
-  www.instagram.com/arken_optics_global/
-  www.youtube.com/@ArkenOpticsGlobal
-  info@arkenoptics.com
-  www.arkenoptics.com

○ ARKEN OPTICS USA

-  www.facebook.com/ArkenOpticsUSA
-  www.instagram.com/arkenopticsusa/
-  www.youtube.com/@ArkenOpticsUsa
-  info@arkenopticsusa.com
-  www.arkenopticsusa.com